

Linear Hall-Effect Sensor ICs with Analog Output Available in a Miniature, Low Profile Surface Mount Package

Features and Benefits

- 3.3 V supply operation
- QVO temperature coefficient programmed at Allegro™ for improved accuracy
- Miniature package options
- High bandwidth, low noise analog output
- High speed chopping scheme minimizes QVO drift across operating temperature range
- Temperature-stable quiescent voltage output and sensitivity
- Precise recoverability after temperature cycling
- Output voltage clamps provide short circuit diagnostic capabilities
- Undervoltage lockout (UVLO)
- Wide ambient temperature range: -40°C to 150°C
- Immune to mechanical stress
- Enhanced EMC performance for stringent automotive applications

Packages

3-pin SOT23-W
2 mm × 3 mm × 1 mm
(suffix LH)



3-pin ultramini SIP
1.5 mm × 4 mm × 3 mm
(suffix UA)

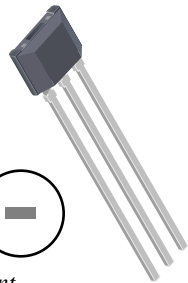

Approximate footprint

Description

New applications for linear output Hall-effect sensors, such as displacement and angular position, require higher accuracy and smaller package sizes. The Allegro A1318 and A1319 linear Hall-effect sensor ICs have been designed specifically to meet both requirements. These temperature-stable devices are available in both surface-mount and through hole packages.

The accuracy of each device is enhanced via end-of-line optimization. Each device features non-volatile memory to optimize device sensitivity and the quiescent voltage output (QVO: output in the absence of a magnetic field) for a given application or circuit. This A1318 and A1319 optimized performance is sustained across the full operating temperature range by programming the temperature coefficient for both sensitivity and QVO at Allegro end-of-line test.

These ratiometric Hall-effect sensor ICs provide a voltage output that is proportional to the applied magnetic field. The quiescent voltage output is adjusted around 50% of the supply voltage.

The features of these linear devices make them ideal for use in automotive and industrial applications requiring high accuracy, and operate across an extended temperature range, -40°C to 150°C .

Each BiCMOS monolithic circuit integrates a Hall element, temperature-compensating circuitry to reduce the intrinsic

Continued on the next page...

Functional Block Diagram

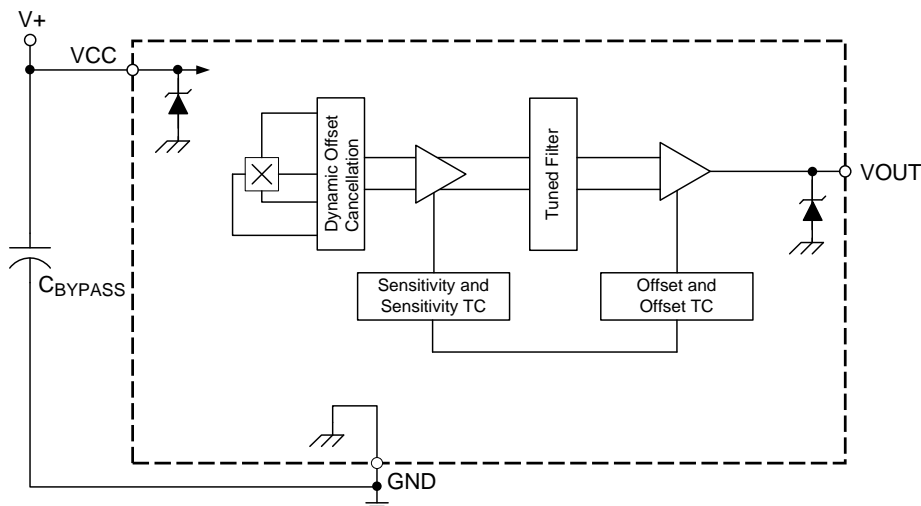

A1318 and A1319

Linear Hall-Effect Sensor ICs with Analog Output Available in a Miniature, Low Profile Surface Mount Package

Description (continued)

sensitivity drift of the Hall element, a small-signal high-gain amplifier, a clamped low-impedance output stage, and a proprietary dynamic offset cancellation technique.

The A1318 and A1319 sensor ICs are offered in two package styles. The LH is a SOT-23W style, miniature, low profile package for surface-mount applications. The UA is a 3-pin, ultra-mini, single inline package (SIP) for through-hole mounting. Both packages are lead (Pb) free, with 100% matte tin leadframe plating.

Selection Guide

Part Number	Output Polarity	Sensitivity (typ) (mV/G)	Packing*	Package
A1318LLHLX-1-T	Forward	1.35	10,000 pieces per reel	3-pin SOT-23W surface mount
A1318LLHLX-2-T	Forward	2.5	10,000 pieces per reel	3-pin SOT-23W surface mount
A1318LUA-2-T	Forward	2.5	500 pieces per bag	3-pin SIP through hole
A1319LLHLX-5-T	Forward	5	10,000 pieces per reel	3-pin SOT-23W surface mount
A1319LUA-5-T	Forward	5	500 pieces per bag	3-pin SIP through hole



*Contact Allegro™ for additional packing options

Absolute Maximum Ratings

Characteristic	Symbol	Notes	Rating	Unit
Forward Supply Voltage	V_{CC}		8	V
Reverse Supply Voltage	V_{RCC}		-0.1	V
Forward Output Voltage	V_{OUT}		7	V
Reverse Output Voltage	V_{ROUT}		-0.1	V
Output Source Current	$I_{OUT(SOURCE)}$	VOUT to GND	2	mA
Output Sink Current	$I_{OUT(SINK)}$	VCC to VOUT	10	mA
Operating Ambient Temperature	T_A	Range L	-40 to 150	°C
Maximum Junction Temperature	$T_{J(max)}$		165	°C
Storage Temperature	T_{stg}		-65 to 170	°C

A1318 and A1319

*Linear Hall-Effect Sensor ICs with Analog Output
Available in a Miniature, Low Profile Surface Mount Package*

Pin-out Diagrams

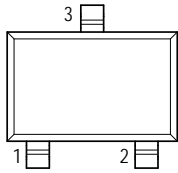

LH Package

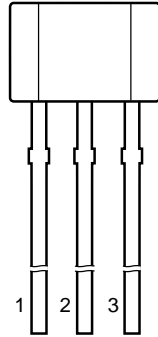

UA Package

Terminal List Table

Name	Number		Description
	LH	UA	
VCC	1	1	Input power supply; tie to GND with bypass capacitor
VOUT	2	3	Output signal
GND	3	2	Ground

THERMAL CHARACTERISTICS may require derating at maximum conditions, see application information

Characteristic	Symbol	Test Conditions	Value	Units
Package Thermal Resistance	$R_{\theta JA}$	Package LH, 1-layer PCB with copper limited to solder pads	228	°C/W
		Package LH, 2-layer PCB with 0.463 in ² of copper area each side connected by thermal vias	110	°C/W
		Package UA, 1-layer PCB with copper limited to solder pads	165	°C/W

A1318 and A1319

Linear Hall-Effect Sensor ICs with Analog Output Available in a Miniature, Low Profile Surface Mount Package

OPERATING CHARACTERISTICS Valid over T_A , $C_{BYPASS} = 0.1 \mu\text{F}$, $V_{CC} = 3.3 \text{ V}$; unless otherwise noted

Characteristic	Symbol	Test Conditions	Min.	Typ.	Max.	Unit ¹	
Electrical Characteristics							
Supply Voltage	V_{CC}		3	3.3	3.63	V	
Undervoltage Threshold ²	V_{UVLOHI}	Tested at $T_A = 25^\circ\text{C}$ and $T_A = 150^\circ\text{C}$ (device powers on)	–	–	3	V	
	V_{UVLOLO}	Tested at $T_A = 25^\circ\text{C}$ and $T_A = 150^\circ\text{C}$ (device powers off)	2.5	–	–	V	
Supply Current	I_{CC}	No load on VOUT	–	7.7	10	mA	
Power On Time ^{3,4}	t_{PO}	$T_A = 25^\circ\text{C}$, $C_{L(\text{PROBE})} = 10 \text{ pF}$	–	50	–	μs	
V_{CC} Ramp Time ^{3,4}	t_{VCC}	$T_A = 25^\circ\text{C}$	0.005	–	100	ms	
V_{CC} Off Level ^{3,4}	V_{CCOFF}	$T_A = 25^\circ\text{C}$	0	–	0.33	V	
Delay to Clamp ^{3,4}	t_{CLP}	$T_A = 25^\circ\text{C}$, $C_L = 10 \text{ nF}$	–	30	–	μs	
Supply Zener Clamp Voltage	V_Z	$T_A = 25^\circ\text{C}$, $I_{CC} = 13 \text{ mA}$	6	7.3	–	V	
Internal Bandwidth ⁴	BW_i	Small signal –3 dB	–	20	–	kHz	
Chopping Frequency ⁵	f_C	$T_A = 25^\circ\text{C}$	–	400	–	kHz	
Output Characteristics							
Output Referred Noise ⁴	V_N	$V_{CC} = 3.3 \text{ V}$, $T_A = 25^\circ\text{C}$, $C_{BYPASS} = \text{open}$, Sens = 5 mV/G, no load on VOUT	–	13	–	$\text{mV}_{(p-p)}$	
Input Referred RMS Noise Density ⁴	V_{NRMS}	$V_{CC} = 3.3 \text{ V}$, $T_A = 25^\circ\text{C}$, $C_{BYPASS} = \text{open}$, Sens = 5 mV/G, no load on VOUT, $f_{\text{measured}} \ll BW_i$	–	2.3	–	$\text{mG}/\sqrt{\text{Hz}}$	
DC Output Resistance ⁴	R_{OUT}		–	<1	–	Ω	
Output Load Resistance ⁴	R_L	VOUT to GND	4.7	–	–	k Ω	
Output Load Capacitance ⁴	C_L	VOUT to GND	–	–	10	nF	
Output Voltage Clamp ⁶	$V_{CLPHIGH}$	$T_A = 25^\circ\text{C}$, $B = +400 \text{ G}$, $R_L = 10 \text{ k}\Omega$ (VOUT to GND)	2.842	2.97	3.069	V	
	V_{CLFLOW}	$T_A = 25^\circ\text{C}$, $B = -400 \text{ G}$, $R_L = 10 \text{ k}\Omega$ (VOUT to VCC)	0.264	0.33	0.462	V	
Sensitivity ⁷	Sens	A1318LLHLX-1-T	$T_A = 25^\circ\text{C}$	1.289	1.35	1.411	mV/G
		A1318LLHLX-2-T		2.388	2.5	2.613	mV/G
		A1318LUA-2-T		2.388	2.5	2.613	mV/G
		A1319LLHLX-5-T		4.85	5	5.15	mV/G
		A1319LUA-5-T		4.85	5	5.15	mV/G
Quiescent Voltage Output (QVO)	$V_{OUT(Q)}$	A1318LLHLX-1-T	$T_A = 25^\circ\text{C}$	1.638	1.65	1.662	V
		A1318LLHLX-2-T		1.638	1.65	1.662	V
		A1318LUA-2-T		1.638	1.65	1.662	V
		A1319LLHLX-5-T		1.635	1.65	1.665	V
		A1319LUA-5-T		1.635	1.65	1.665	V

Continued on the next page...

A1318 and A1319

Linear Hall-Effect Sensor ICs with Analog Output Available in a Miniature, Low Profile Surface Mount Package

OPERATING CHARACTERISTICS (continued) Valid over T_A , $C_{BYPASS} = 0.1 \mu\text{F}$, $V_{CC} = 3.3 \text{ V}$; unless otherwise noted

Characteristic	Symbol	Test Conditions	Min.	Typ.	Max.	Unit ¹	
Electrical Characteristics (continued)							
Sensitivity Temperature Coefficient	TC_{Sens}	A1318LLHLX-1-T	Programmed at $T_A = 150^\circ\text{C}$, calculated relative to Sens at 25°C	0.08	0.12	0.16	%/ $^\circ\text{C}$
		A1318LLHLX-2-T		0.08	0.12	0.16	%/ $^\circ\text{C}$
		A1318LUA-2-T		0.08	0.12	0.16	%/ $^\circ\text{C}$
		A1319LLHLX-5-T		0.08	0.12	0.16	%/ $^\circ\text{C}$
		A1319LUA-5-T		0.08	0.12	0.16	%/ $^\circ\text{C}$
Error Components							
Linearity Sensitivity Error	Lin_{ERR}		–	± 1.5	–	%	
Symmetry Sensitivity Error	Sym_{ERR}		–	± 1.5	–	%	
Ratiometry Quiescent Voltage Output Error ⁸	$Rat_{VOUT(Q)}$	Across supply voltage range (relative to $V_{CC} = 5 \text{ V}$)	–	± 1.5	–	%	
Ratiometry Sensitivity Error ⁸	Rat_{Sens}	Across supply voltage range (relative to $V_{CC} = 5 \text{ V}$)	–	± 1.5	–	%	
Ratiometry Clamp Error ⁹	$Rat_{VOUTCLP}$	$T_A = 25^\circ\text{C}$, across supply voltage range (relative to $V_{CC} = 5 \text{ V}$)	–	± 1.5	–	%	
Drift Characteristics							
Typical Quiescent Voltage Output Drift Across Temperature Range	$\Delta V_{OUT(Q)}$	A1318LLHLX-1-T	$T_A = 150^\circ\text{C}$	–15	–	5	mV
		A1318LLHLX-2-T		–18	–	8	mV
		A1318LUA-2-T		–13	0	13	mV
		A1319LLHLX-5-T		–20	–	20	mV
		A1319LUA-5-T		–15	0	15	mV
Sensitivity Drift Due to Package Hysteresis	$\Delta Sens_{PKG}$	$T_A = 25^\circ\text{C}$, after temperature cycling	–	± 2	–	%	

¹ 1 G (gauss) = 0.1 mT (millitesla).

² On power-up, the output of the device is held low until V_{CC} exceeds V_{UVLOHI} . After the device is powered, the output remains valid until V_{CC} drops below V_{UVLOLO} , when the output is pulled low.

³ See the Characteristic Definitions section.

⁴ Determined by design and characterization, not evaluated at final test.

⁵ f_C varies as much as approximately $\pm 20\%$ across the full operating ambient temperature range and process.

⁶ V_{CLPLOW} and $V_{CLPHIGH}$ scale with V_{CC} due to ratiometry.

⁷ Sensitivity drift through the life of the part, $\Delta Sens_{LIFE}$, can have a typical error value $\pm 3\%$ in addition to package hysteresis effects.

⁸ Percent change from actual value at $V_{CC} = 3.3 \text{ V}$, for a given temperature.

⁹ Percent change from actual value at $V_{CC} = 3.3 \text{ V}$, $T_A = 25^\circ\text{C}$.

Characteristic Definitions

Power On Time When the supply is ramped to its operating voltage, the device output requires a finite time to react to an input magnetic field. Power On Time, t_{PO} , is defined as the time it takes for the output voltage to begin responding to an applied magnetic field after the power supply has reached its minimum specified operating voltage, $V_{CC}(\text{min})$, as shown in figure 1.

Delay to Clamp A large magnetic input step may cause the clamp to overshoot its steady state value. The Delay to Clamp, t_{CLP} , is defined as the time it takes for the output voltage to settle within 1% of its steady state value, after initially passing through its steady state voltage, as shown in figure 2.

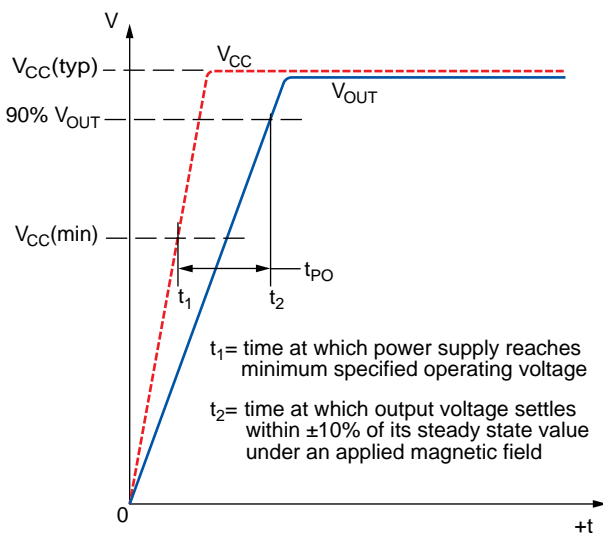

Figure 1. Definition of Power On Time, t_{PO}

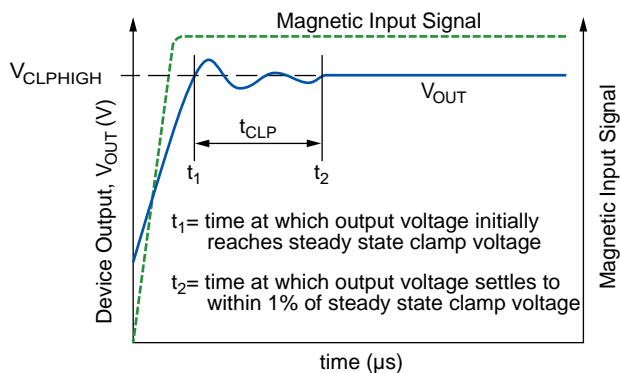

Figure 2. Definition of Delay to Clamp, t_{CLP}

Quiescent Voltage Output In the quiescent state (no significant magnetic field: $B = 0$ G), the output, $V_{OUT(Q)}$, is at a constant ratio to the supply voltage, V_{CC} , across the entire operating ranges of V_{CC} and Operating Ambient Temperature, T_A .

Quiescent Voltage Output Drift Across Temperature Range Due to internal component tolerances and thermal considerations, the Quiescent Voltage Output, $V_{OUT(Q)}$, may drift due to temperature changes within the Operating Ambient Temperature, T_A . For purposes of specification, the Quiescent Voltage Output Drift Across Temperature Range, $\Delta V_{OUT(Q)}$ (mV), is defined as:

$$\Delta V_{OUT(Q)} = V_{OUT(Q)(T_A)} - V_{OUT(Q)(25^\circ\text{C})} \quad (1)$$

Sensitivity The amount of the output voltage change is proportional to the magnitude and polarity of the magnetic field applied. This proportionality is specified as the magnetic sensitivity, Sens (mV/G), of the device and is defined as:

$$\text{Sens} = \frac{V_{OUT(B+)} - V_{OUT(B-)}}{(B+) - (B-)} \quad (2)$$

where $B+$ is the magnetic flux density in a positive field (south polarity) and $B-$ is the magnetic flux density in a negative field (north polarity).

Sensitivity Temperature Coefficient The device sensitivity changes as temperature changes, with respect to its Sensitivity Temperature Coefficient, TC_{SENS} . TC_{SENS} is programmed at 150°C , and calculated relative to the baseline sensitivity programming temperature of 25°C . TC_{SENS} is defined as:

$$TC_{SENS} = \left(\frac{\text{Sens}_{T2} - \text{Sens}_{T1}}{\text{Sens}_{T1}} \times 100 \right) \left(\frac{1}{T2 - T1} \right) \quad (\%/^\circ\text{C}) \quad (3)$$

where $T1$ is the baseline Sens programming temperature of 25°C , and $T2$ is the TC_{SENS} programming temperature of 150°C .

The ideal value of Sens across the full ambient temperature range, $\text{Sens}_{IDEAL(T_A)}$, is defined as:

$$\text{Sens}_{IDEAL(T_A)} = \text{Sens}_{T1} \times [100 (\%) + TC_{SENS} (T_A - T1)] \quad (4)$$

Sensitivity Drift Across Temperature Range Second order sensitivity temperature coefficient effects cause the magnetic sensitivity, Sens, to drift from its ideal value across the operating ambient temperature range, T_A . For purposes of specification,

the Sensitivity Drift Across Temperature Range, $\Delta\text{Sens}_{\text{TC}}$, is defined as:

$$\Delta\text{Sens}_{\text{TC}} = \frac{\text{Sens}_{T_A} - \text{Sens}_{\text{IDEAL}(T_A)}}{\text{Sens}_{\text{IDEAL}(T_A)}} \times 100 \quad (\%) \quad (5)$$

Sensitivity Drift Due to Package Hysteresis Package stress and relaxation can cause the device sensitivity at $T_A = 25^\circ\text{C}$ to change during and after temperature cycling. This change in sensitivity follows a hysteresis curve. For purposes of specification, the Sensitivity Drift Due to Package Hysteresis, $\Delta\text{Sens}_{\text{PKG}}$, is defined as:

$$\Delta\text{Sens}_{\text{PKG}} = \frac{\text{Sens}_{(25^\circ\text{C})(2)} - \text{Sens}_{(25^\circ\text{C})(1)}}{\text{Sens}_{(25^\circ\text{C})(1)}} \times 100 \quad (\%) \quad (6)$$

where $\text{Sens}_{(25^\circ\text{C})(1)}$ is the programmed value of sensitivity at $T_A = 25^\circ\text{C}$, and $\text{Sens}_{(25^\circ\text{C})(2)}$ is the value of sensitivity at $T_A = 25^\circ\text{C}$ after temperature cycling T_A up to 150°C , down to -40°C , and back to up 25°C .

Linearity Sensitivity Error The A1318 and A1319 are designed to provide linear output in response to a ramping applied magnetic field. Consider two magnetic fields, B1 and B2. Ideally, the sensitivity of a device is the same for both fields, for a given supply voltage and temperature. Linearity error is present when there is a difference between the sensitivities measured at B1 and B2.

Linearity Sensitivity Error, Lin_{ERR} , is calculated separately for positive ($\text{Lin}_{\text{ERR}+}$) and negative ($\text{Lin}_{\text{ERR}-}$) applied magnetic fields. Lin_{ERR} (%) is measured and defined as:

$$\text{Lin}_{\text{ERR}+} = \left(1 - \frac{\text{Sens}_{(B+)(2)}}{\text{Sens}_{(B+)(1)}}\right) \times 100 \quad (\%) \quad (7)$$

$$\text{Lin}_{\text{ERR}-} = \left(1 - \frac{\text{Sens}_{(B-)(2)}}{\text{Sens}_{(B-)(1)}}\right) \times 100 \quad (\%)$$

where:

$$\text{Sens}_{B_x} = \frac{|V_{\text{OUT}(B_x)} - V_{\text{OUT}(Q)}|}{B_x} \quad (8)$$

and B_x are positive and negative magnetic fields, with respect to the quiescent voltage output, such that

$$|B_{(+) (2)}| > |B_{(+) (1)}| \text{ and } |B_{(-) (2)}| > |B_{(-) (1)}|$$

The effective linearity error is:

$$\text{Lin}_{\text{ERR}} = \max(|\text{Lin}_{\text{ERR}+}|, |\text{Lin}_{\text{ERR}-}|) \quad (9)$$

The output voltage clamps, V_{CLPHIGH} and V_{CLPLOW} , limit the operating magnetic range of the applied field in which the device provides a linear output. The maximum positive and negative applied magnetic fields in the operating range can be calculated:

$$|B_{\text{MAX}(+)}| = \frac{V_{\text{CLPHIGH}} - V_{\text{OUT}(Q)}}{\text{Sens}} \quad (10)$$

$$|B_{\text{MAX}(-)}| = \frac{V_{\text{OUT}(Q)} - V_{\text{CLPLOW}}}{\text{Sens}}$$

Symmetry Sensitivity Error The magnetic sensitivity of the device is constant for any two applied magnetic fields of equal magnitude and opposite polarities. Symmetry error, Sym_{ERR} (%), is measured and defined as:

$$\text{Sym}_{\text{ERR}} = \left(1 - \frac{\text{Sens}_{(B+)}}{\text{Sens}_{(B-)}}\right) \times 100 \quad (\%) \quad (11)$$

where Sens_{B_x} is as defined in equation 10, and B+ and B- are positive and negative magnetic fields such that $|B+| = |B-|$.

Ratiometry Error The A1318 and A1319 provide ratiometric output. This means that the Quiescent Voltage Output, $V_{\text{OUT}(Q)}$, magnetic sensitivity, Sens, and clamp voltages, V_{CLPHIGH} and V_{CLPLOW} , are proportional to the supply voltage, V_{CC} . In other words, when the supply voltage increases or decreases by a certain percentage, each characteristic also increases or decreases by the same percentage. Error is the difference between the measured change in the supply voltage relative to 3.3 V, and the measured change in each characteristic.

The ratiometric error in quiescent voltage output, $\text{Rat}_{V_{\text{OUT}(Q)}}$ (%), for a given supply voltage, V_{CC} , is defined as:

$$\text{Rat}_{V_{\text{OUT}(Q)}} = \left(1 - \frac{V_{\text{OUT}(Q)(V_{\text{CC}})} / V_{\text{OUT}(Q)(3.3V)}}{V_{\text{CC}} / 3.3 \text{ (V)}}\right) \times 100 \quad (\%) \quad (12)$$

The ratiometric error in magnetic sensitivity, Rat_{Sens} (%), for a given supply voltage, V_{CC} , is defined as:

$$\text{Rat}_{\text{Sens}} = \left(1 - \frac{\text{Sens}_{(V_{\text{CC}})} / \text{Sens}_{(3.3V)}}{V_{\text{CC}} / 3.3 \text{ (V)}}\right) \times 100 \quad (\%) \quad (13)$$

The ratiometric error in the clamp voltages, $\text{Rat}_{V_{\text{OUTCLP}}}$ (%), for a given supply voltage, V_{CC} , is defined as:

$$\text{Rat}_{V_{\text{OUTCLP}}} = \left(1 - \frac{V_{\text{CLP}(V_{\text{CC}})} / V_{\text{CLP}(3.3V)}}{V_{\text{CC}} / 3.3 \text{ (V)}}\right) \times 100 \quad (\%) \quad (14)$$

where V_{CLP} is either V_{CLPHIGH} or V_{CLPLOW} .

A1318 and A1319

Linear Hall-Effect Sensor ICs with Analog Output Available in a Miniature, Low Profile Surface Mount Package

Undervoltage Lockout The A1318 and A1319 provide an undervoltage lockout feature which ensures that the device outputs a V_{OUT} signal only when V_{CC} is above certain thresholds. The undervoltage lockout feature provides a hysteresis of operation to eliminate indeterminate output states.

The output of the A1318 and A1319 is held low (GND) until V_{CC} exceeds V_{UVLOHI} . After V_{CC} exceeds V_{UVLOHI} , the device V_{OUT} output is enabled, providing a ratiometric output voltage that is proportional to the input magnetic signal and V_{CC} . If V_{CC} should drop back down below V_{UVLOLO} for longer than t_{UVLO} after the device is powered up, the output would be pulled low (see figure 3) until V_{UVLOHI} is reached again and V_{OUT} would be reenabled.

V_{CC} Ramp Time The time taken for V_{CC} to ramp from 0 V to $V_{CC}(typ)$, 3.3 V (see figure 4).

V_{CC} Off Level For applications in which the V_{CC} pin of the A1318 or A1319 is being power-cycled (for example using a multiplexer to toggle the part on and off), the specification of V_{CC} Off Level, V_{CCOFF} , determines how high a V_{CC} off voltage can be tolerated while still ensuring proper operation and startup of the device (see figure 4).

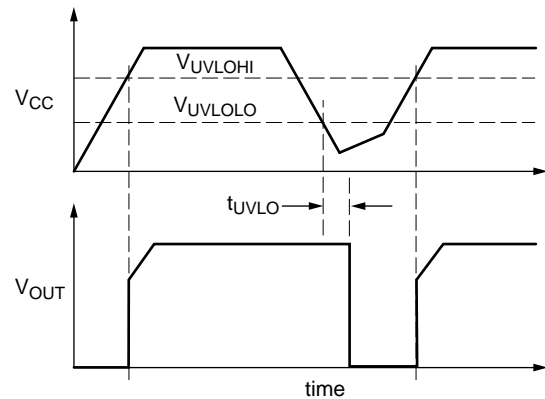

Figure 3. Definition of Undervoltage Lockout

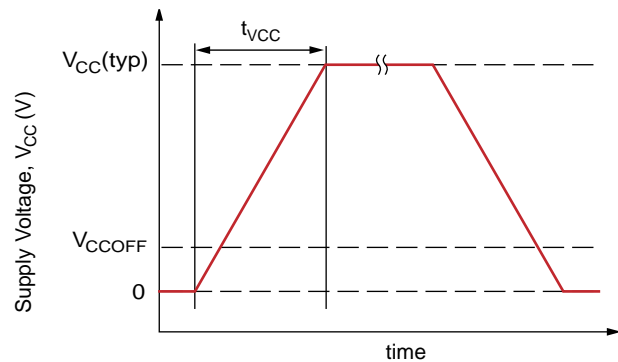

Figure 4. Definition of V_{CC} Ramp Time, t_{VCC}

Application Information

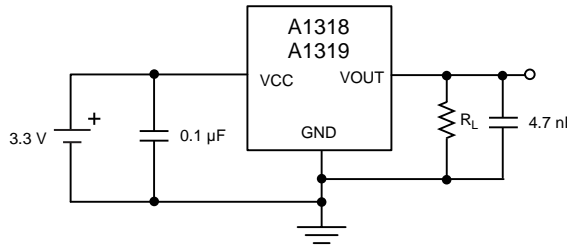

Figure 5. Typical Application Circuit

Chopper Stabilization Technique

When using Hall-effect technology, a limiting factor for switchpoint accuracy is the small signal voltage developed across the Hall element. This voltage is disproportionately small relative to the offset that can be produced at the output of the Hall sensor IC. This makes it difficult to process the signal while maintaining an accurate, reliable output over the specified operating temperature and voltage ranges. Chopper stabilization is a unique approach used to minimize Hall offset on the chip. Allegro employs a patented technique to remove key sources of the output drift induced by thermal and mechanical stresses. This offset reduction technique is based on a signal modulation-demodulation process. The undesired offset signal is separated from the magnetic field-induced signal in the frequency domain, through modulation. The subsequent demodulation acts as a modulation process for the offset, causing the magnetic field-induced signal to recover its original spectrum at base band, while the DC offset becomes a high-frequency signal. The magnetic-sourced signal

then can pass through a low-pass filter, while the modulated DC offset is suppressed. In addition to the removal of the thermal and mechanical stress related offset, this novel technique also reduces the amount of thermal noise in the Hall sensor IC while completely removing the modulated residue resulting from the chopper operation. The chopper stabilization technique uses a high frequency sampling clock. For demodulation process, a sample and hold technique is used. This high-frequency operation allows a greater sampling rate, which results in higher accuracy and faster signal-processing capability. This approach desensitizes the chip to the effects of thermal and mechanical stresses, and produces devices that have extremely stable quiescent Hall output voltages and precise recoverability after temperature cycling. This technique is made possible through the use of a BiCMOS process, which allows the use of low-offset, low-noise amplifiers in combination with high-density logic integration and sample-and-hold circuits.

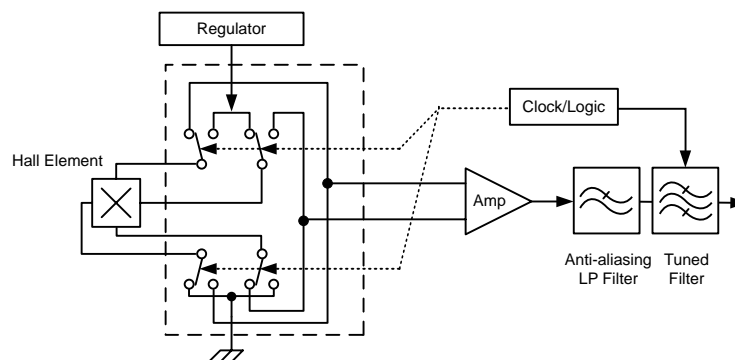
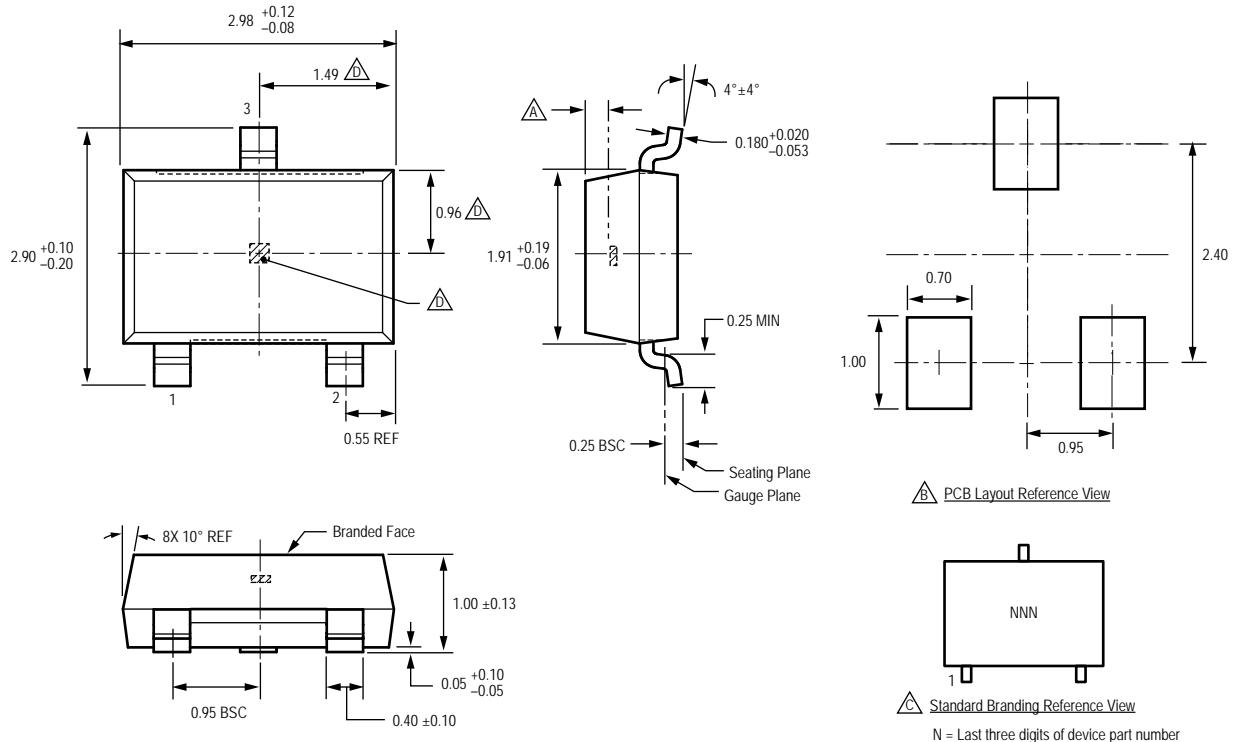

Figure 6. Chopper Stabilization Technique





A1318 and A1319

*Linear Hall-Effect Sensor ICs with Analog Output
Available in a Miniature, Low Profile Surface Mount Package*

Package LH, 3-Pin (SOT-23W)



For Reference Only; not for tooling use (reference DWG-2840)
Dimensions in millimeters
Dimensions exclusive of mold flash, gate burrs, and dambar protrusions
Exact case and lead configuration at supplier discretion within limits shown

-  Active Area Depth, 0.28 mm REF
-  Reference land pattern layout
All pads a minimum of 0.20 mm from all adjacent pads; adjust as necessary to meet application process requirements and PCB layout tolerances
-  Branding scale and appearance at supplier discretion
-  Hall element, not to scale

N = Last three digits of device part number

A1318 and A1319

*Linear Hall-Effect Sensor ICs with Analog Output
Available in a Miniature, Low Profile Surface Mount Package*

Revision History

Revision	Revision Date	Description of Revision
Rev. 1	June 27, 2014	Update product offerings, $V_{CLPHIGH}$

Copyright ©2009-2014, Allegro MicroSystems, LLC

Allegro MicroSystems, LLC reserves the right to make, from time to time, such departures from the detail specifications as may be required to permit improvements in the performance, reliability, or manufacturability of its products. Before placing an order, the user is cautioned to verify that the information being relied upon is current.

Allegro's products are not to be used in any devices or systems, including but not limited to life support devices or systems, in which a failure of Allegro's product can reasonably be expected to cause bodily harm.

The information included herein is believed to be accurate and reliable. However, Allegro MicroSystems, LLC assumes no responsibility for its use; nor for any infringement of patents or other rights of third parties which may result from its use.

For the latest version of this document, visit our website:

www.allegromicro.com



Allegro MicroSystems, LLC
115 Northeast Cutoff
Worcester, Massachusetts 01615-0036 U.S.A.
1.508.853.5000; www.allegromicro.com