

3 Stereo Inputs and 4-Channel Outputs Volume, Balance, Fader and Selectable Input Gain

FEATURES

- Operation range : 2.7V ~ 6.5V
- 3 stereo inputs with selectable input gain
- 4 independent speaker controls for fader and balance
- Independent mute function
- Volume control in 1.25 dB/step
- I²C interface
- Components less and good PSRR
- Housed in SOP20, SSOP20 packages

APPLICATIONS

- Portable audio device
- Car stereo audio
- Hi-Fi audio system

DESCRIPTION

The MS6720 is a 3 stereo inputs/4-channel outputs digital control audio processor for the low voltage operation. Volume, balance (left/right), and fader (front/rear) processor are incorporated into a single chip. The MS6720 also has selectable input gain. All functions are programmable via the serial I²C bus. The default states of the chip as the power is on are: the volume is -78.75dB, the stereo 4 is selected, all the speakers are mute and the gains of the input stage are 0dB. The stereo 4 is connected internally, but not available on pins.

BLOCK DIAGRAM

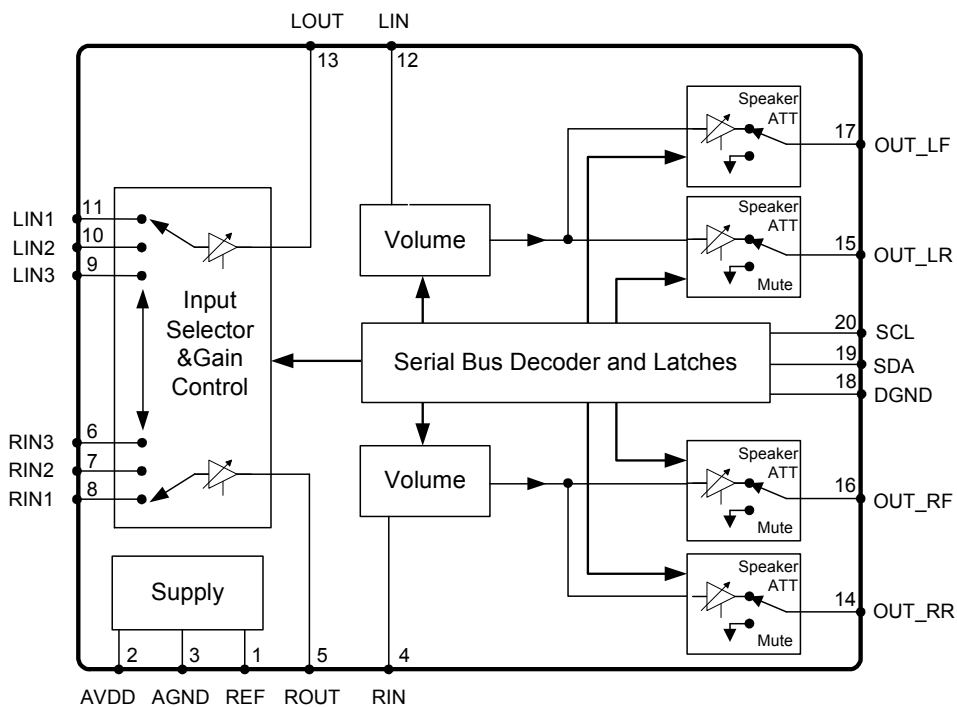

PIN CONFIGURATION

Symbol	Pin	Description
REF	1	Analog Reference Voltage (1/2VDD)
VDD	2	Supply Input Voltage
AGND	3	Analog Ground
RIN	4	Audio Processor Right Channel Input
ROUT	5	Gain Output and Input Selector for Right Channel
RIN3	6	Right Channel Input 3
RIN2	7	Right Channel Input 2
RIN1	8	Right Channel Input 1
LIN3	9	Left Channel Input 3
LIN2	10	Left Channel Input 2
LIN1	11	Left Channel Input 1
LIN	12	Audio Processor Left Channel Input
LOUT	13	Gain Output and Input Selector for Left Channel
OUT_RR	14	Right Rear Speaker Output
OUT_LR	15	Left Rear Speaker Output
OUT_RF	16	Right Front Speaker Output
OUT_LF	17	Left Front Speaker Output
DGND	18	Digital Ground
SDA	19	I ² C Data Input
SCL	20	I ² C Clock Input

ORDERING INFORMATION

Package	Part number	Packaging Marking	Transport Media
20-Pin SOP (lead free)	MS6720GTR	MS6720G	1k Units Tape and Reel
20-Pin SOP (lead free)	MS6720GU	MS6720G	36 Units Tube
20-Pin SSOP (lead free)	MS6720SSGTR	MS6720G	2.5k Units Tape and Reel
20-Pin SSOP (lead free)	MS6720SSGU	MS6720G	56 Units Tube

ABSOLUTE MAXIMUM RATINGS

Symbol	Parameter	Rating	Unit
VDD	Supply Voltage	6.5	V
V _{ESD}	Electrostatic Handling	-3000 to 3000	V
T _{STG}	Storage Temperature Range	-65 to 150	°C
T _A	Operating Ambient Temperature Range	-40 to 85	°C
T _J	Maximum Junction Temperature	150	°C
T _S	Soldering Temperature, 10 seconds	260	°C
R _{THJA}	Thermal Resistance from Junction to Ambient in Free Air	210 210	°C/W
	SOP20		
	SSOP20		

OPERATING RATINGS

Symbol	Parameter	Min	Typ	Max	Unit
V _{DD}	Supply Voltage	2.7	-	6.5	V

5V ELECTRICAL CHARACTERISTICS

(T_a=25°C, All stages 0dB, f=1kHz, C_{REF}=22uF, refer to the application circuit; unless otherwise specified)

Symbol	Parameter	Conditions	Min	Typ	Max	Unit
Supply						
I _Q	Quiescent Current	V _{IN} =0V	-	12.2	12.5	mA
PSRR	Power Supply Rejection Ratio	C _{REF} = 22uF, f = 100Hz	55	60	-	dB
Input Selectors						
R _{IN}	Input Resistance	Input 1,2,3	35	50	70	kΩ
G _{IN}	Input Gain Range	Gain	0	-	11.25	dB
G _{STEP}	Step Resolution		-	3.75	-	dB
ERR _G	Gain Setting error		-0.2	0	0.2	dB
Volume control						
CR _{VOL}	Volume Control Range	Attenuation	-78.75	-	0	dB
RES _{VOL}	Volume Step Resolution		-	1.25	-	dB
ERR _{VOL}	Volume Setting Error	A _v = 0 to -40dB	-0.5	0	1	dB
		A _v = -40 to -60dB	-1	0	5	dB
Speaker Attenuators						
CR _{SPK}	Speaker Control Range	Attenuation	-37.5	-	0	dB
RES _{SPK}	Speaker Step Resolution		-	1.25	-	dB
ERR _{SPK}	Speaker Setting Error		-0.2	0	0.1	dB
MUTE	Output Mute Attenuation		-	-65	-60	dB
General						
VO _{MAX}	Maximum Output Voltage Swing	(THD+N)/S <0.3%	-	4.5	-	V _{pp}
THD+N	Total Harmonic Distortion Plus Noise	V _{OUT} =2V _{pp}	-	-75	-	dB
			-	0.0177	-	%
S/N	Signal-to-Noise Ratio	V _{OUT} =4V _{pp}	-	97	-	dB
CS	Channel Separation Left/Right		93	97	-	dB
Bus Input						
V _{IH}	Bus High Input Level		2	-	-	V
V _{IL}	Bus Low Input Level		-	-	0.8	V

2.7V ELECTRICAL CHARACTERISTICS

($T_a=25^\circ\text{C}$, All stages 0dB, $f=1\text{kHz}$, $C_{\text{REF}}=22\mu\text{F}$, refer to the application circuit; unless otherwise specified)

Symbol	Parameter	Conditions	Min	Typ	Max	Unit
Supply						
I_Q	Quiescent Current	$V_{\text{IN}}=0\text{V}$	-	8.7	9	mA
PSRR	Power Supply Rejection Ratio	$C_{\text{REF}}=22\mu\text{F}$, $f=100\text{Hz}$	53	58	-	dB
General						
$V_{\text{O MAX}}$	Maximum Output Voltage Swing	$(\text{THD+N})/S < 0.3\%$	-	2.5	-	Vpp
THD+N	Total Harmonic Distortion Plus Noise	$V_{\text{OUT}}=2\text{Vpp}$	-	-50	-	dB
			-	0.3	-	%
S/N	Signal-to-Noise Ratio	$V_{\text{OUT}}=2.5\text{Vpp}$	90	94	-	dB
CS	Channel Separation Left/Right		90	94	-	dB

TYPICAL PERFORMANCE CHARACTERISTICS

($T_a=25^\circ\text{C}$, All stages 0dB, $f=1\text{kHz}$, $C_{\text{REF}}=22\mu\text{F}$, refer to the application circuit; unless otherwise specified)

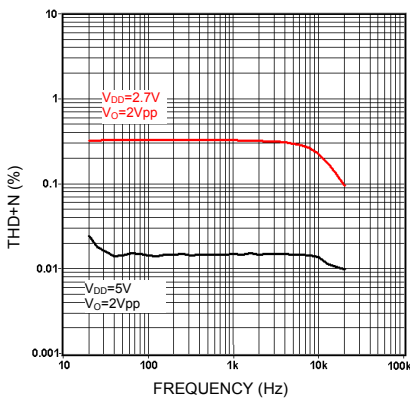

THD+N vs. Frequency

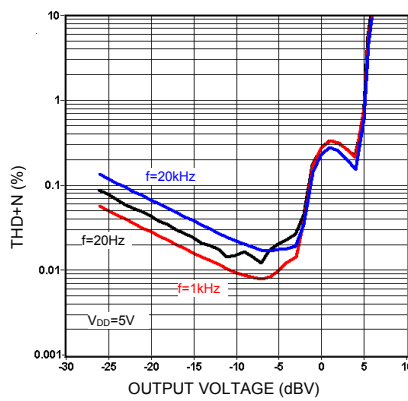

THD+N vs. Output Voltage

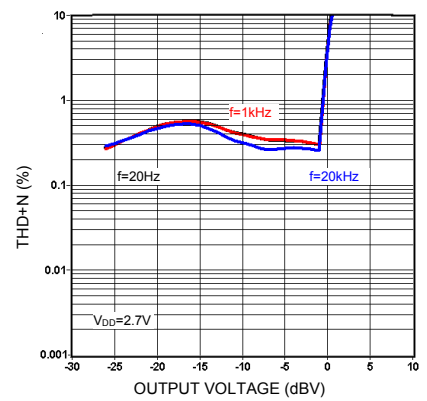

THD+N vs. Output Voltage

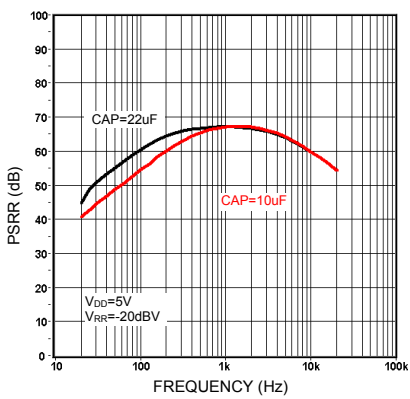

PSRR vs. Frequency

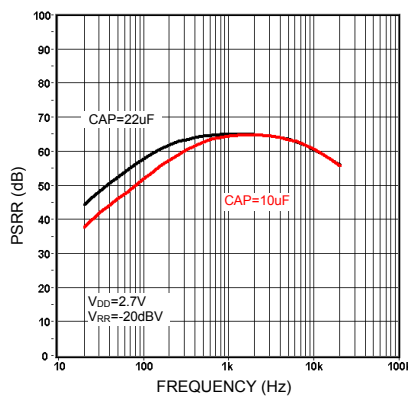

PSRR vs. Frequency

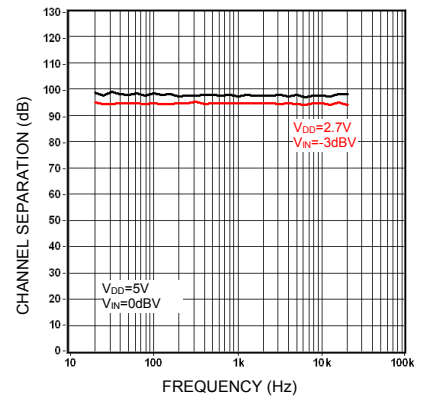

Channel Separation vs. Frequency

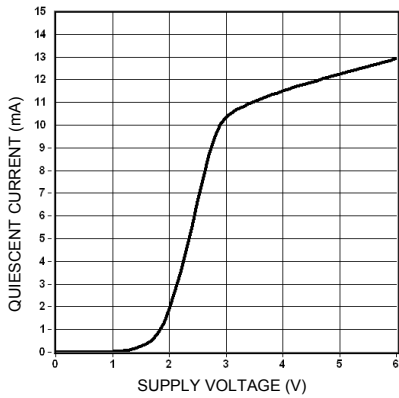

Quiescent Current vs. Supply Voltage

I²C BUS DESCRIPTION

Start and Stop Conditions

A start condition is activated when the SCL is set to HIGH and SDA shifts from HIGH to LOW state. The stop condition is activated when SCL is set to HIGH and SDA shifts from LOW to HIGH state. Please refer to the timing diagram below.

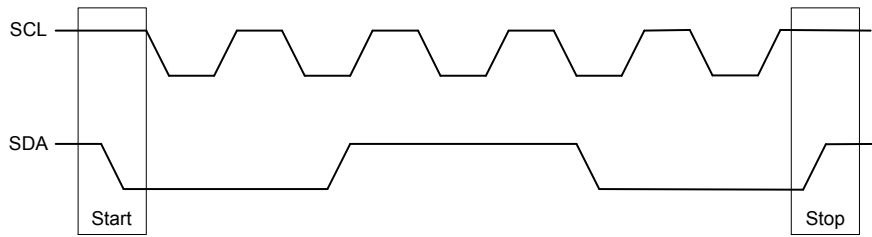

SCL : Serial Clock Line, SDA : Serial Data Line

Data Validity

A data on the SDA line is considered valid and stable only when the SCL signal is in HIGH state. The HIGH and LOW states of the SDA line can only change when the SCL signal is LOW. Please refer to the figure below.

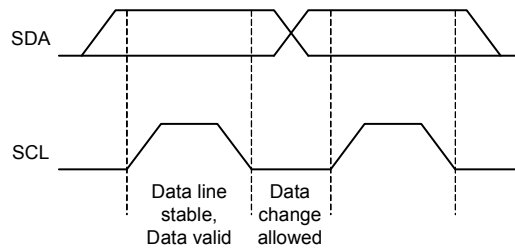

Byte Format

Every byte transmitted to the SDA line consists of 8 bits. Each byte must be followed by an acknowledge bit. The MSB is transmitted first.

Acknowledge

During the Acknowledge clock pulse, the master (up) put a resistive HIGH level on the SDA line. The peripheral (audio processor) that acknowledges has to pull-down (LOW) the SDA line during the Acknowledge clock pulse so that the SDA line is in a stable LOW state during this clock pulse. Please refer to the diagram below.

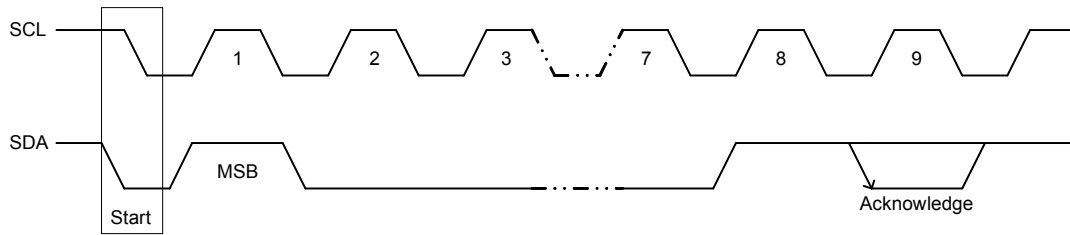

The audio processor that has been addressed has to generate an Acknowledge after receiving each byte, otherwise, the SDA line will remain at the HIGH level during the ninth (9th) clock pulse. In this case, the master transmitter can generate the STOP information in order to abort the transfer.

Timing of SDA and SCL Bus Lines

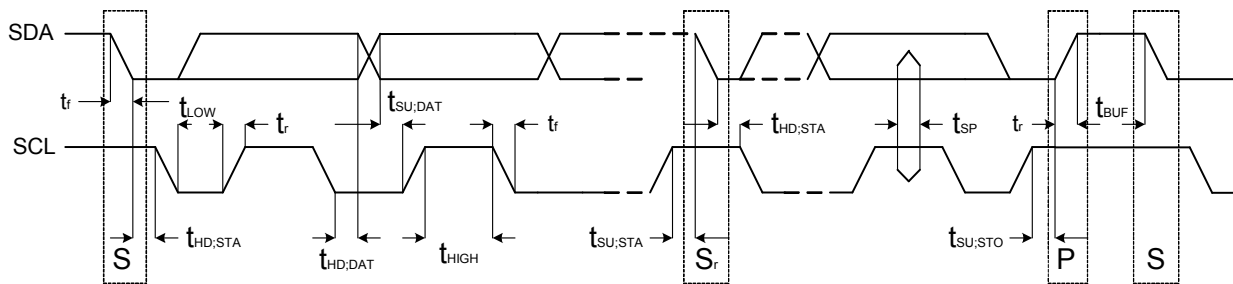

Standard Mode

Symbol	Parameter	Min	Max	Unit
f_{SCL}	SCL clock frequency	0	100	kHz
$t_{HD:STA}$	Hold time (repeated) START condition. After this period, the first clock pulse is generated	4.0	-	us
t_{LOW}	LOW period of the SCL clock	4.7	-	us
t_{HIGH}	HIGH period of the SCL clock	4.0	-	us
$t_{SU:STA}$	Set-up time for a repeated START condition	4.7	-	us
$t_{HD:DAT}$	Data hold time: For I ² C-bus devices	0	3.45	us
$t_{SU:DAT}$	Data-set-up time	250	-	ns
t_r	Rise time of both SDA and SCL signals	-	1000	ns
t_f	Fall time of both SDA and SCL signals	-	300	ns
$t_{SU:STO}$	Set-up time for STOP condition	4.0	-	us
t_{BUF}	Bus free time between a STOP and START condition	4.7	-	us
C_b	Capacitive load for each bus line	-	400	pF
V_{nL}	Noise margin at the LOW level for each connected device (including hysteresis)	$0.1V_{DD}$	-	V
V_{nH}	Noise margin at the HIGH level for each connected device (including hysteresis)	$0.2V_{DD}$	-	V

BUS INTERFACE

Data are transmitted to and from the MCU to the MS6720 via the SDA and SCL. The SDA and SCL make up the BUS interface. It should be noted that pull-up resistors must be connected to the positive supply voltage.

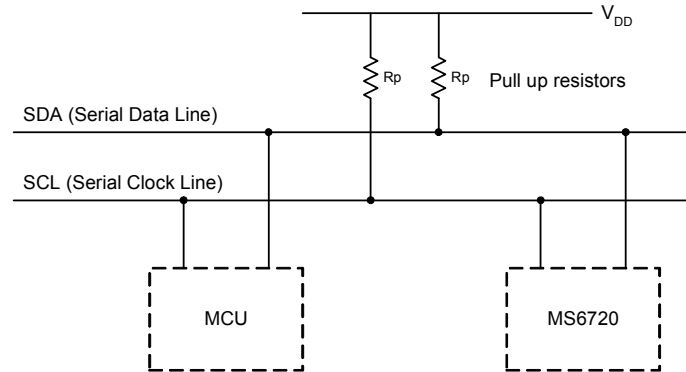

Interface Protocol

The format consists of the following

- A START condition
- A chip address byte including the MS6720 address. (7bits)
- The 8th bit of the byte must be "0".(write=0, read=1)
- MS6720 must always acknowledge the end of each transmitted byte.
- A data sequence (N-bytes + Acknowledge)
- A STOP condition

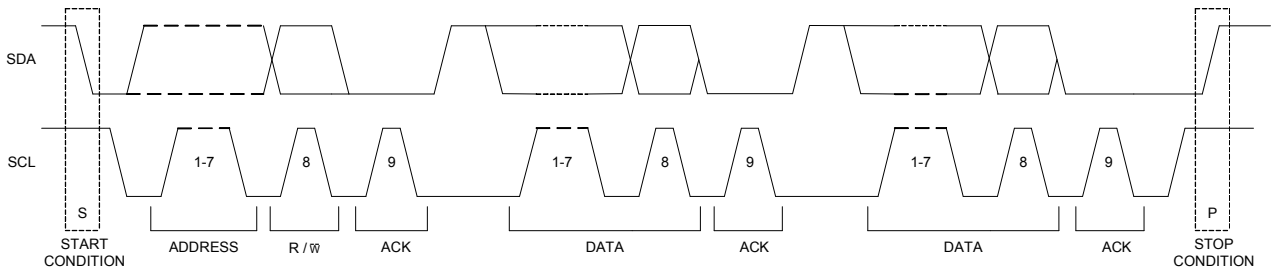

Address Code

The chip address of the MS6720 is 88H.

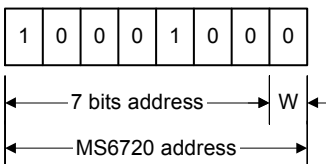

Data Bytes Description

The default states of the chip as the power is on are: the volume is -78.75dB, the stereo 4 is selected, all the speakers are mute and the gains of the input stage are 0dB.

MSB					LSB			Function
0	0	B2	B1	B0	A2	A1	A0	Volume Control
1	1	0	B1	B0	A2	A1	A0	Speaker ATT LR
1	1	1	B1	B0	A2	A1	A0	Speaker ATT RR
1	0	0	B1	B0	A2	A1	A0	Speaker ATT LF
1	0	1	B1	B0	A2	A1	A0	Speaker ATT RF
0	1	0	G1	G0	1	S1	S0	Audio Switch

Where Ax = 1.25dB/step; Bx = 10dB/step; Cx = 2dB/step; Gx = 3.75dB/step

Volume

MSB					LSB			Function
0	0	B2	B1	B0	A2	A1	A0	Volume 1.25 dB steps
					0	0	0	0
					0	0	1	-1.25
					0	1	0	-2.5
					0	1	1	-3.75
					1	0	0	-5
					1	0	1	-6.25
					1	1	0	-7.5
					1	1	1	-8.75
0	0	B2	B1	B0	A2	A1	A0	Volume 10dB steps
		0	0	0				0
		0	0	1				-10
		0	1	0				-20
		0	1	1				-30
		1	0	0				-40
		1	0	1				-50
		1	1	0				-60
		1	1	1				-70

The default volume is -78.75dB.

Speaker Attenuator

MSB				LSB				Function (dB)
1	0	0	B1	B0	A2	A1	A0	Speaker LF
1	0	1	B1	B0	A2	A1	A0	Speaker RF
1	1	0	B1	B0	A2	A1	A0	Speaker LR
1	1	1	B1	B0	A2	A1	A0	Speaker RR
					0	0	0	0
					0	0	1	-1.25
					0	1	0	-2.5
					0	1	1	-3.75
					1	0	0	-5
					1	0	1	-6.25
					1	1	0	-7.5
					1	1	1	-8.75
			0	0				0
			0	1				-10
			1	0				-20
			1	1				-30
			1	1	1	1	1	Mute

LF: Left Front, RF: Right Front, LR: Left Rear, RR: Right Rear
The default state is mute.

Audio Switch

MSB				LSB				Function
0	1	0	G1	G0	1	S1	S0	Audio Switch
						0	0	Stereo 1
						0	1	Stereo 2
						1	0	Stereo 3
						1	1	*Stereo 4
			0	0				+11.25dB
			0	1				+7.5dB
			1	0				+3.75dB
			1	1				0dB

* The stereo 4 is connected internally, but not available on pins.
The default state is stereo 4 and gain 0dB.

Examples

Set Volume at -37.5dB.

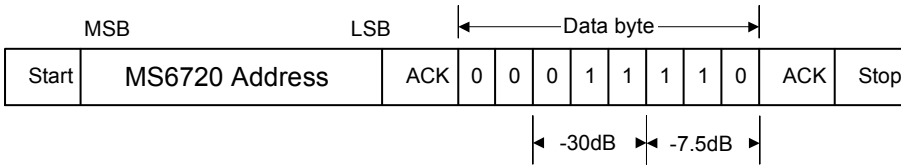

Set Speaker RF at -30dB.

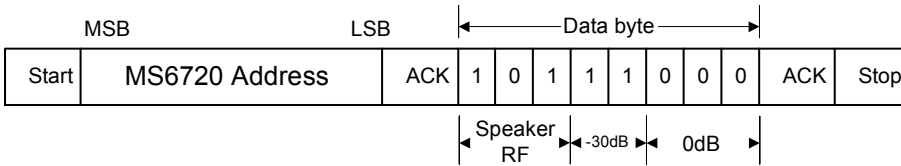

Set Speaker RR in mute-on.

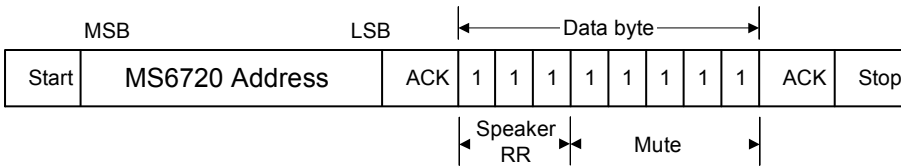

Set Stereo 2 Input with gain of +7.5dB

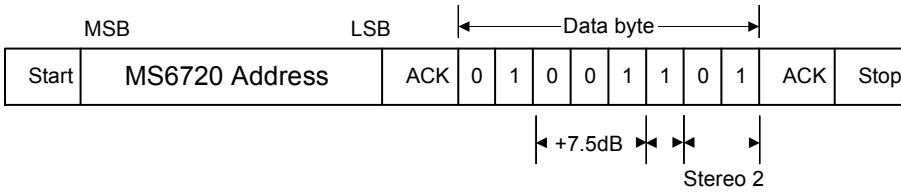

APPLICATION INFORMATION

Basic Application Example

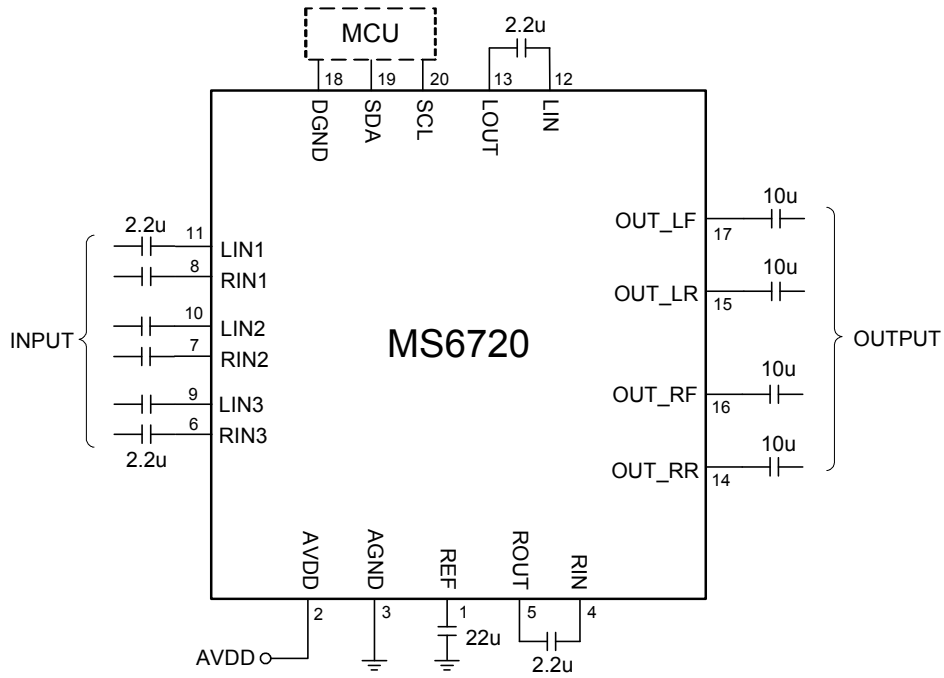

EXTERNAL DIMENSIONS

SOP20 (300mil)

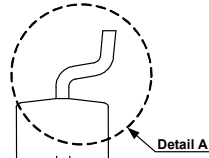
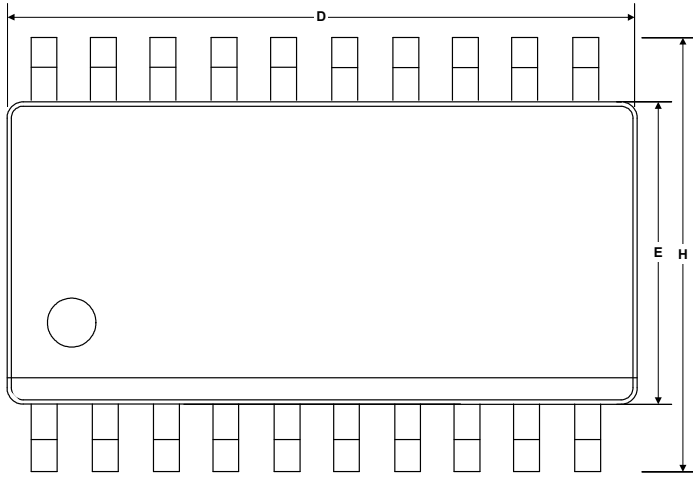

Symbol	Dimension in mm		Dimension in inch	
	Min	Max	Min	Max
A	2.35	2.65	0.0926	0.1043
A1	0.10	0.30	0.004	0.0118
B	0.33	0.51	0.013	0.020
C	0.23	0.32	0.0091	0.0125
e	1.27 BSC		0.050 BSC	
D	12.6	13	0.4961	0.5118
E	7.4	7.60	0.2914	0.2992
H	10.00	10.65	0.394	0.419
L	0.40	1.27	0.016	0.050
h	0.25	0.75	0.010	0.029
θ	0°	8°	0°	8°

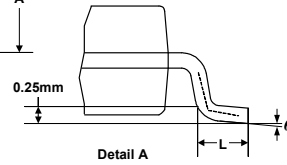
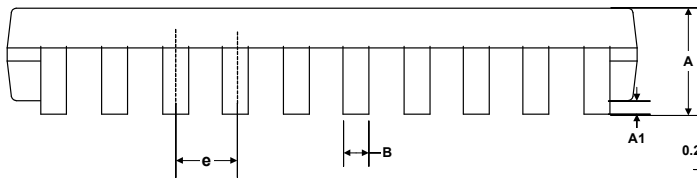

SSOP20

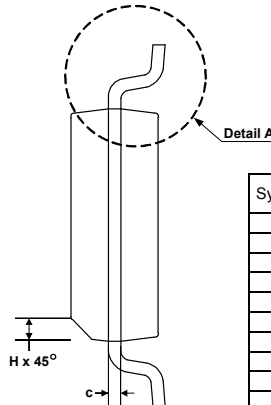
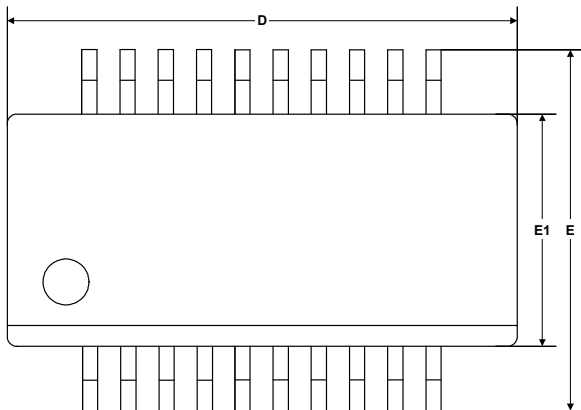

Symbol	Dimension in mm		Dimension in inch	
	Min	Max	Min	Max
A	1.35	1.75	0.053	0.069
A1	0.10	0.25	0.004	0.010
A2	1.50		0.059	
b	0.20	0.30	0.008	0.012
c	0.18	0.25	0.007	0.010
e	0.635 BASIC		0.025 BASIC	
D	8.56	8.74	0.337	0.344
E	5.79	6.20	0.228	0.244
E1	3.81	3.99	0.150	0.157
L	0.41	1.27	0.016	0.050
h	0.25	0.50	0.010	0.020
L1	0.254 BASIC		0.010 BASIC	
ZD	1.4732 REF		0.058 REF	
R1	0.20	0.33	0.008	0.013
R	0.20	0.008		
θ	0°	8°	0°	8°
$\theta 1$	0°	0°		
$\theta 2$	5°	15°	5°	15°

